

ITEM 1 - LEFT FRAME ASSY
5UN-003-3

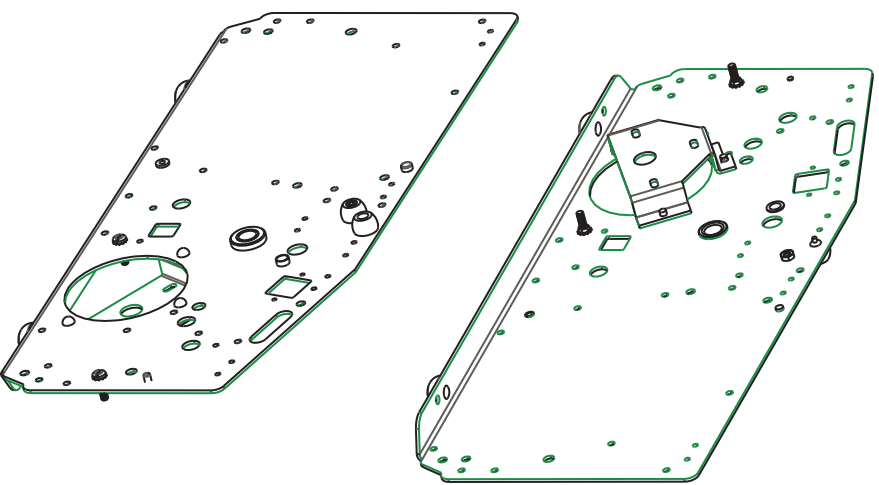

ITEM 2 - RIGHT FRAME ASSY
5UN-004-3

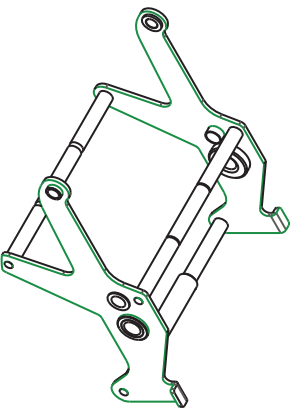

ITEM 3 - ROCKER, FINAL ASSY
5UN-014-3



ITEM 4 - UPPER FEED WHEEL
5UN-018-0

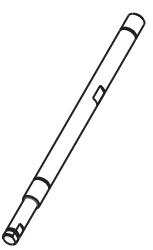

ITEM 5 - UPPER FEED SHAFT
5UN-019-0

BP755E ITEMS LIST



Better Packages, Inc.®

Shelton, CT 06484

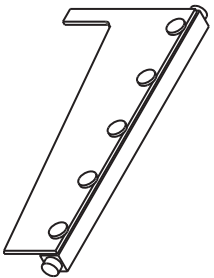

ITEM 6 - KNIFE ASSY
5UN-021-1

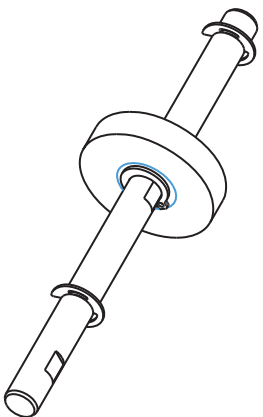

ITEM 7 - FEED WHEEL SHAFT ASSY
5UN-025-1

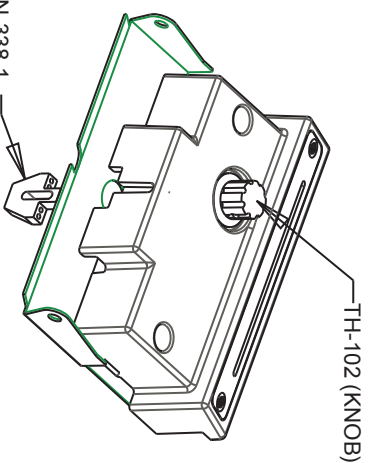

5UN-338-1
(TAPE SENSOR ASSY)

ITEM 8 - ASSY, TOP HEATER, L.V.

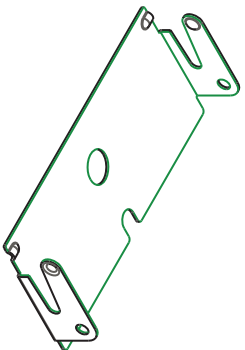

ITEM 9 - LOWER LIP
5UN-028-0

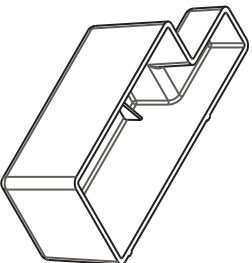

ITEM 10 - TANK
5UN-033-0

MODEL	PART NUMBER
BP755ES	5UN-329-1
BP755EM	
BP755ESA	5UN-329-2
BP755EMA	
BP755EJA	

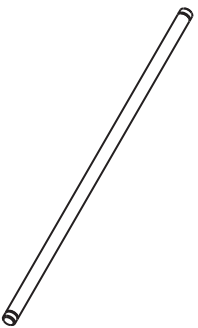

ITEM 11 - PLATFORM SUPPORT ROD
5UN-035-0

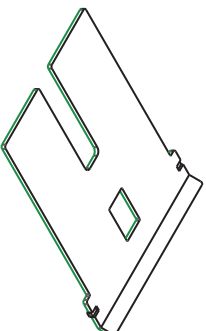

ITEM 12 - UPPER TAPE PLATE
5UN-037-0

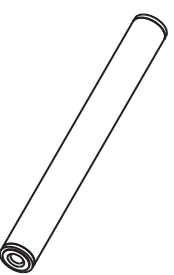

ITEM 15 - UPPER ROLLER ASSY
5UN-040-1

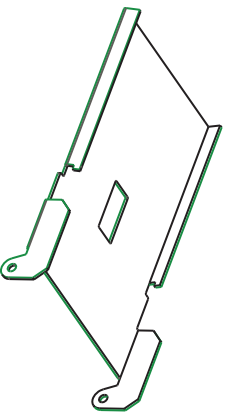

ITEM 13 - LOWER TAPE PLATE
5UN-038-0

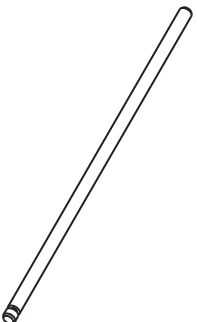

ITEM 14 - UPPER ROLLER SHAFT
5UN-039-0

BP755E ITEMS LIST

 **Better Packages, Inc.**®

Shelton, CT 06484

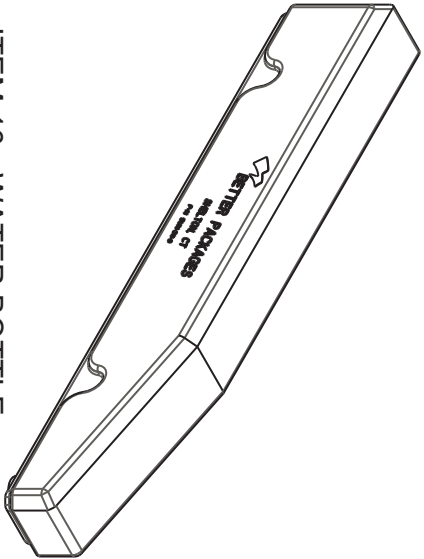

ITEM 16 - WATER BOTTLE
5UN-311-0

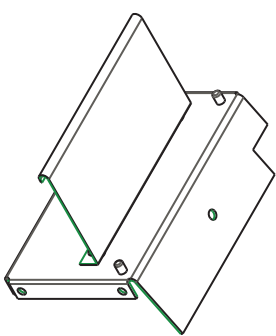

ITEM 17 - MOTOR COVER ASSY
5UN-056-2

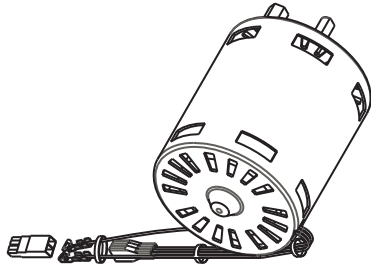

ITEM 19 - MOTOR ASSY

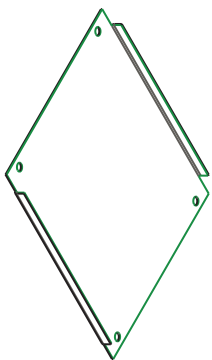

ITEM 18 - MOTOR PAN
5UN-057-0

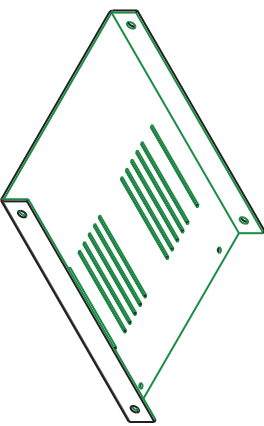

ITEM 20 - BOTTOM SEPARATOR
033-003-0

MODEL	PART NUMBER
BP755ES	5UN-341-1
BP755ESA	
BP755EM	5UN-341-2
BP755EMA	
BP755EJA	5UN-341-3

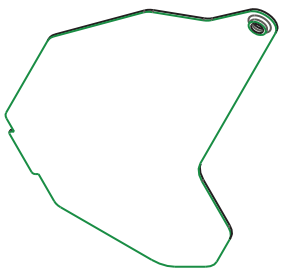

ITEM 21 - ROLL GUIDE W/ADJ. NUT, RIGHT
5UN-337-0R

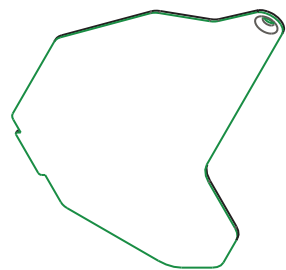

ITEM 22 - ROLL GUIDE W/ADJ. NUT, LEFT
5UN-337-0L

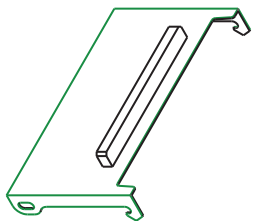

ITEM 23 - FRONT COVER ASSY
5UN-074-1

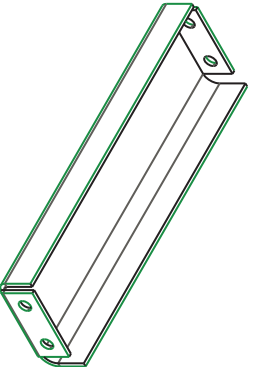

ITEM 24 - FRONT CROSSMEMBER
5UN-076-0

BP755E ITEMS LIST



Better Packages, Inc.®

Shelton, CT 06484

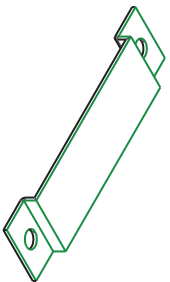

ITEM 25 - CABLE CLAMP PLATE
5UN-082-0



ITEM 26 - ROCKER RETURN SPRING
5UN-118-0

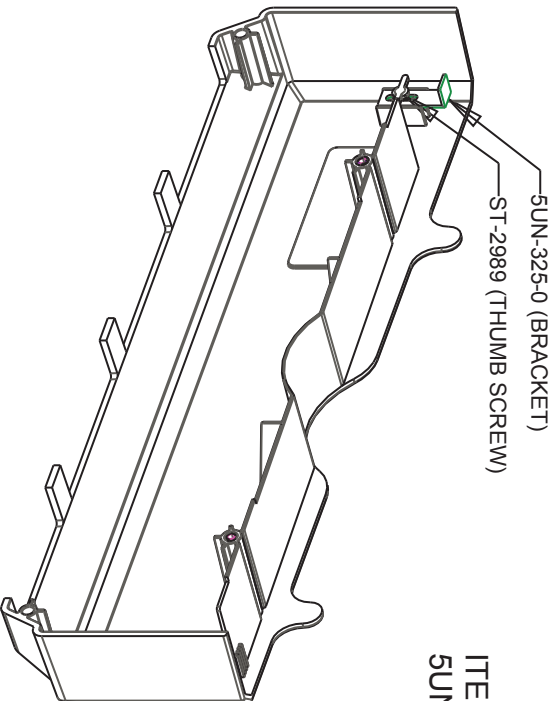

ITEM 27 - ASSY, LEFT SIDE COVER
5UN-312-1

ITEM 28 - CABLE, 16 COND.
5UN-310-0

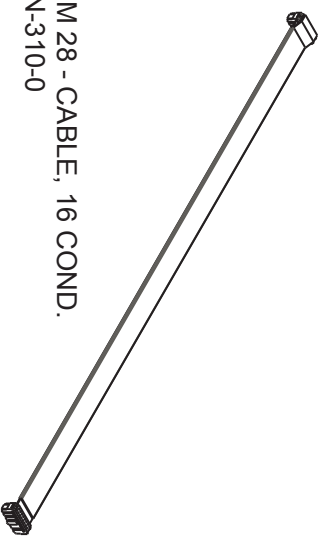

5UN-309-1 (KEYBOARD - INCH)
5UN-309-2 (KEYBOARD - CM)

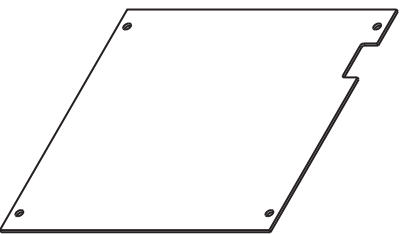

ST-3260
(INTERLOCK SWITCH)

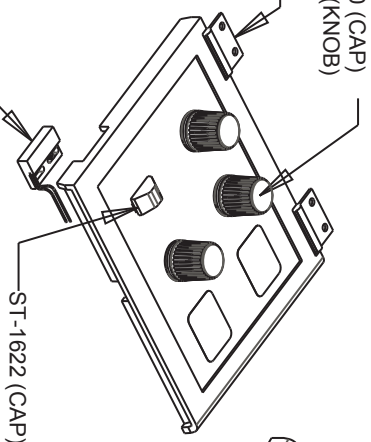

ITEM 29 - ASSY, CONTROLLER BOARD

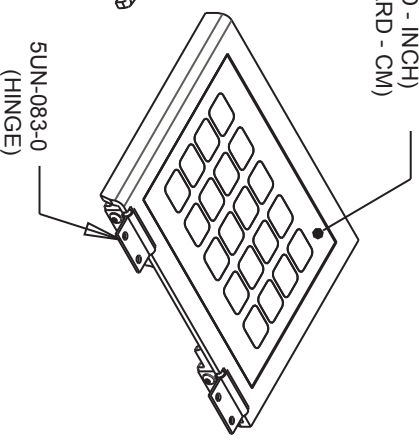

ITEM 30 - KEYBOARD CONSOLE ASSY

MODEL	PART NUMBER
BP755ES	5UN-308-1
BP755ESA	5UN-318-1
BP755EM	5UN-308-2
BP755EMA	5UN-318-2
BP755EJA	5UN-318-3

MODEL	PART NUMBER
BP755ESA BP755EJA	5UN-334-1
BP755EMA	5UN-334-2
BP755ES	5UN-355-1
BP755EM	5UN-355-2

BP755E ITEMS LIST

Better Packages, Inc.[®]
Shelton, CT 06484

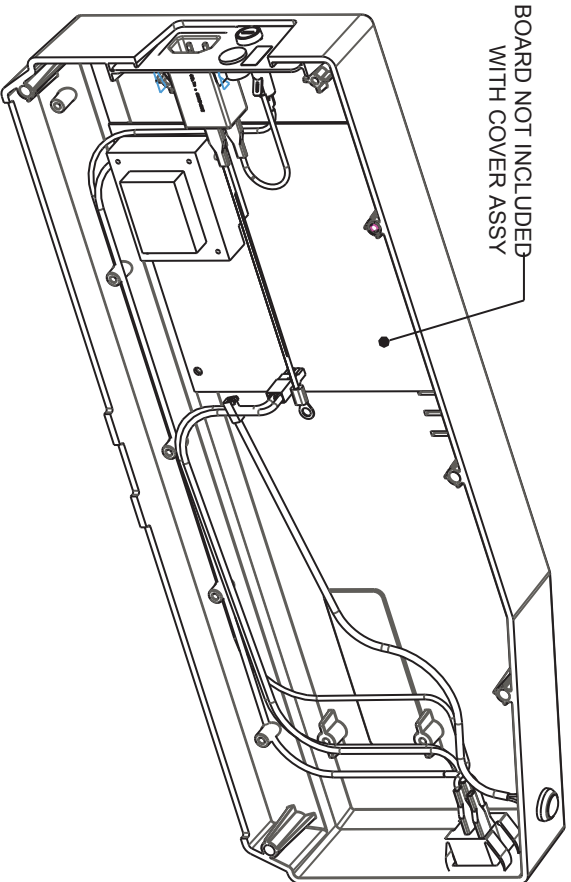

BOARD NOT INCLUDED
WITH COVER ASSY

ITEM 31 - ASSY, RIGHT SIDE COVER
5UN-348

MODEL	PART NUMBER
BP755ES	5UN-348-1
BP755ESA	
BP755EJA	
BP755EM	5UN-348-2
BP755EMA	

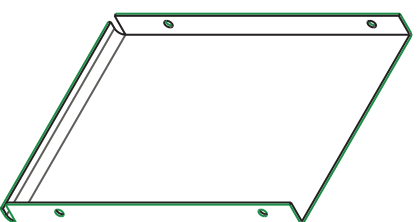

ITEM 32 - COVER, REAR
5UN-136-0

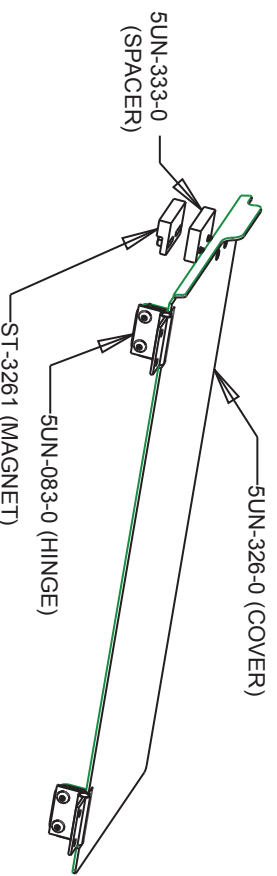

ITEM 33 - TOP COVER & HINGE ASSY
5UN-326-1

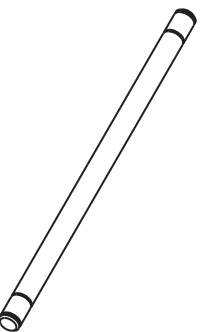

ITEM 35 - ROCKER PIVOT SHAFT
5UN-143-0

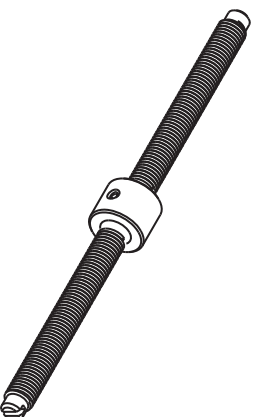

ITEM 37 - TAPE GUIDE ADJUSTMENT SCREW
5UN-336-1

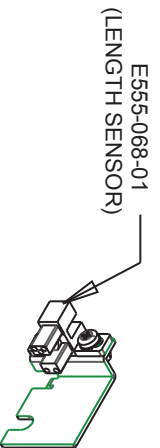

ITEM 38 - ASSY, SENSOR BRACKET
5UN-302-1

BP755E ITEMS LIST

Better Packages, Inc.[®]

Shelton, CT 06484

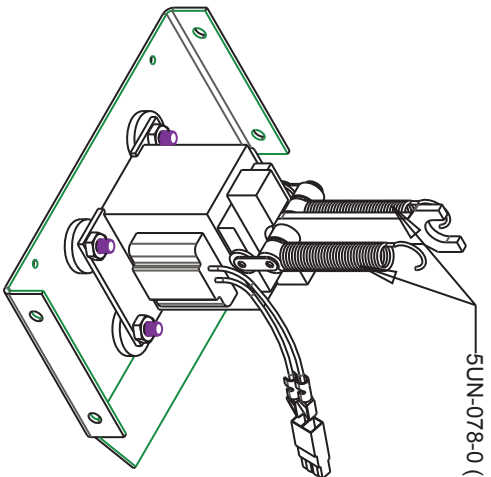

SUN-078-0 (TENSION SPRING)

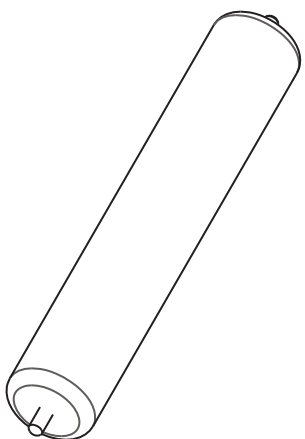

ITEM 40 - WOOD ROLLER ASSY
600-015-0

MODEL	PART NUMBER
BP755ES	5UN-354-1
BP755ESA	
BP755EM	5UN-354-2
BP755EMA	
BP755EJA	5UN-354-3

ITEM 39 - SOLENOID ASSY

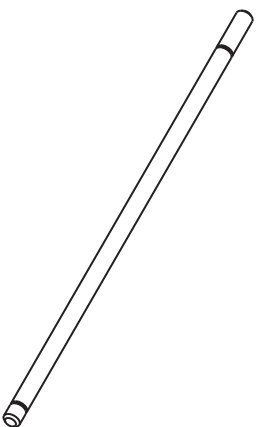

ITEM 41 - LOWER BLADE SHAFT
600-025-0

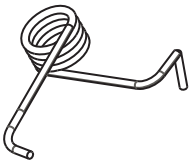

ITEM 42 - BLADE TORSION SPRING
600-107-0

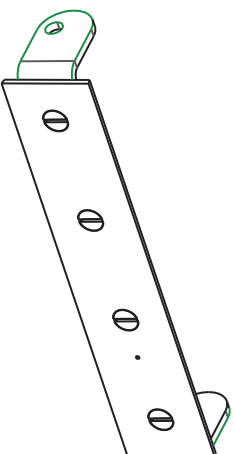

ITEM 43 - LOWER BLADE & YOKE ASSY
600-108-1



ITEM 44 - PULLEY, TIMING BELT (SMALL)
ST-48

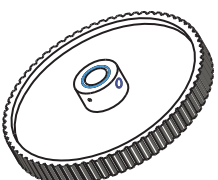

ITEM 45 - PULLEY, TIMING BELT (LARGE)
ST-49

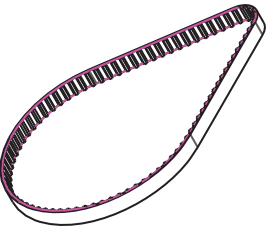

ITEM 46 - TIMING BELT
ST-51

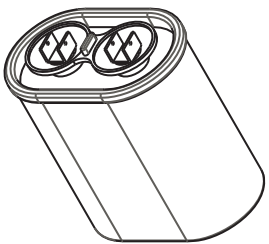

ITEM 47 - CAPACITOR

MODEL	PART NUMBER
BP755ES BP755ESA	ST-2952
BP755EM BP755EMA	ST-835
BP755EJA	ST-2953



ITEM 48 - PIVOT ROD RETAINER
E580-RA



ITEM 49 - WIRE CLAMP
E-676

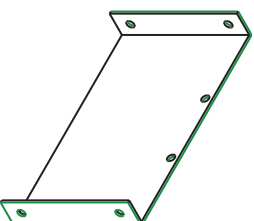

ITEM 50 - CENTER SEPARATOR
033-004-0

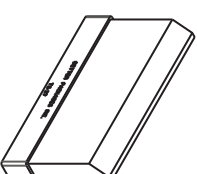

ITEM 88 - BRUSH
TS-37



ITEM 34
TAPE WEIGHT
SUN-340-1



ITEM 51
SET SCREW, #10-32 x 1/4"
023-176-0



ITEM 52
RETAINING RING, 3/16 SHAFT
023-505-0



ITEM 53
LOCKWASHER, EXTERNAL #10
1110



ITEM 54
LOCKWASHER, INTERNAL #10
1210



ITEM 56
SET SCREW, #10-32 x 3/16
BM-172



ITEM 57
WASHER, #8 FLAT, .06 THK
BS40



ITEM 58
BURR WASHER, 1/4-20 THIN
BW 1/4 THIN



ITEM 60
E-RING, 3/8 SHAFT
FM-101



ITEM 61
E-RING, 5/16 SHAFT
FM-94



ITEM 62
SCREW, #10-32 X 1/4, PHP
K201C



ITEM 65
SCREW, #6-32 x 5/16 RHP
K241C



ITEM 59
SCREW, #6 x 1/4 PHP
EA70



ITEM 66
WASHER, FLAT, 1/32 THK
K34A 1/32



ITEM 68
WASHER, FLAT, 1/64 THK
K34A 1/64





ITEM 69
WASHER, TENSION
PR-20



ITEM 71
SCREW, #4 x 3/8, SELF TAPPING
ST-1596



ITEM 74
NUT, KEPS #6-32
ST-492



ITEM 75
CABLE TIE, 4" LG
ST-190



ITEM 78
SCREW #10-32 X 3/16, PHP
ST-2011



ITEM 79
NUT, KEPS #10-32
ST-2888



ITEM 82
SCREW, #6-32 x 3/4" LG, BHT
ST-3273



ITEM 83
SPACER
ST-850



ITEM 84
SPACER
ST-851

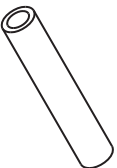

ITEM 85
TUBING, 3/8 OD x 1/16 WALL
ST-881

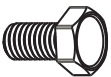

ITEM 86
SCREW, #10-32 x 3/8, HEX HD
ST-892



ITEM 87
SCREW, #10-32 x 3/8, PHP
TO105



ITEM 89
WASHER
TS426A



ITEM 90
RETAINING RING, 3/16 SHAFT
WKO

BP755E ITEMS LIST



Better Packages, Inc.®

Shelton, CT 06484

REVISED APRIL 2011

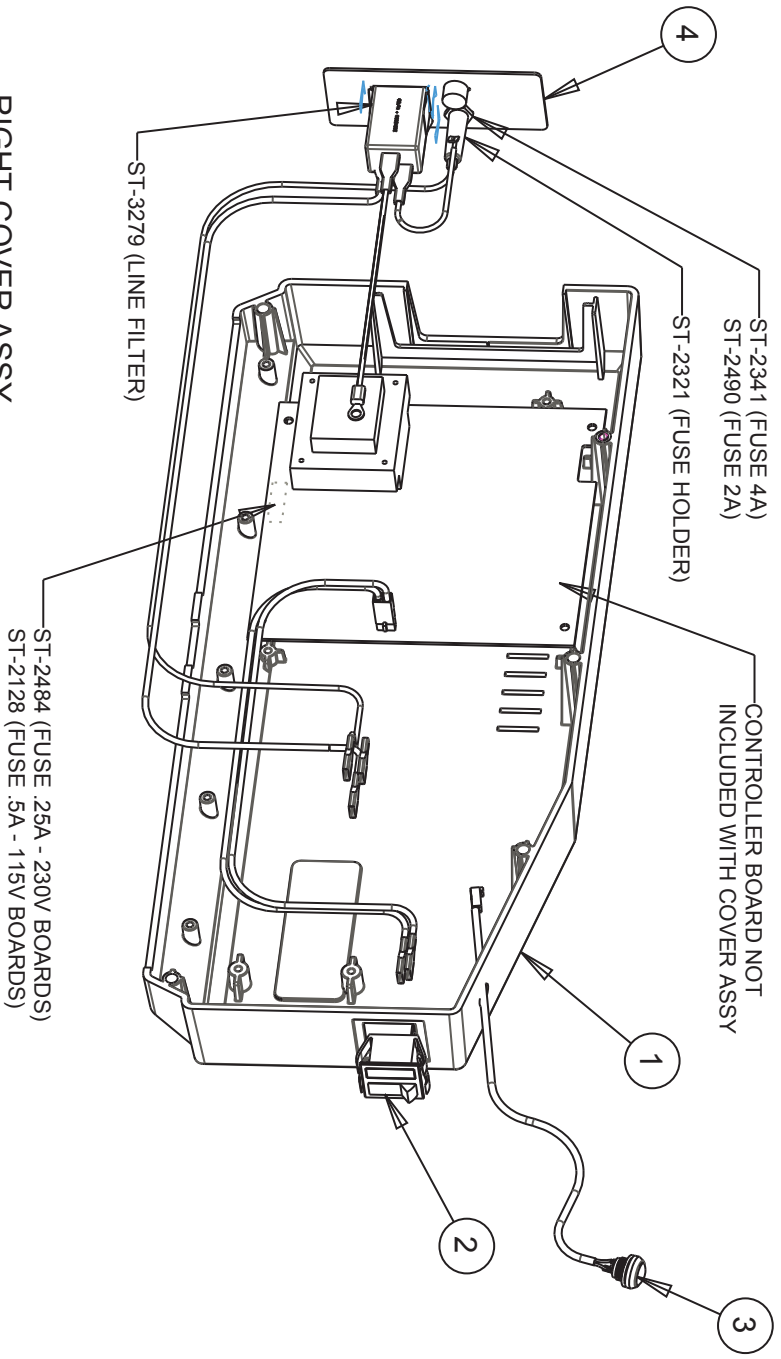

RIGHT COVER ASSY

4	5UN-320-1	ASSY, POWER ENTRY, 115V	ES, ESA, EJA
4	5UN-320-2	ASSY, POWER ENTRY, 230V	EM, EMA
3	5UN-347-1	ASSY, RANDOM SWITCH	ALL MODELS
2	ST-113	SWITCH, DPST, ROCKER, 4A/115V	ES, ESA, EJA
2	ST-1989	SWITCH, DPST, ROCKER, 250V	EM, EMA
1	5UN-313-0	COVER, RIGHT SIDE	ALL MODELS
ITEM	PART NUMBER	DESCRIPTION	MODEL



Better Packages, Inc.®

BP755E ITEMS LIST

Shelton, CT 06484